

DIM.A = 1.50 x No. of Spaces
 DIM.B = DIM.A + 5.3
 DIM.C = DIM.A + 4.5
 DIM.D = DIM.A + 3.2

* Available in 02 through 05 circuits

Material :

- * Base:
High Temperature Plastic UL 94V-0
Color White
- * Contact :
Phosphor Bronze, With Tin plated
- * Tab :
Brass, With Tin plated

Ordering Code:

CP15 04 M 1 P R 0 -NH
 ① ② ③ ④ ⑤ ⑥ ⑦ ⑧

- ① Series No.
- ② No. of Circuits: 2~5 Pin
- ③ M= SMT Type
- ④ Plating: 1= 3.05um(120u") ~ 4.88um(192u")
Matte Tin over 1.27um(50u") Nickel
- ⑤ Connector Type: P= Plug
- ⑥ Packing Options: R= Tape & Reel packing
- ⑦ Option: 0= Standard
- ⑧ Other option:
-NH= For Lead Free IR Processes
and Halogen-Free

Halogen-Free

Lead Free Process

RoHS Compliant

						DATE	UNIT: mm / inch	TITLE: For CP15 series Plug conn.	瀚荃股份有限公司 CviLux Corporation			
						DRAWN BY: Karen	8/13-14'	TOLERANCE UNLESS OTHERWISE SPECIFIED				
	Karen	8/13-14'	ECNT114178		ENGINEER: Sun	8/14-14'	.X ± 0.30/.012	.X* ± r'	MATERIAL:			
	Clark	08/08-12	ECN12186-0		CHECKED BY: Eisley	8/15-14'	.XX ± 0.20/.008	.X* ±	FINISH:	DRAWING NO. CP1501SB		
SYM	NAME	DATE	REVISIONS		APPROVED BY: Eisley	8/15-14'	.XXX ± 0.10/.004	.XX* ±		PART NO. CP15**M1PRO-NH		
									SCALE	4 / 1	SHEET	1 OF 4

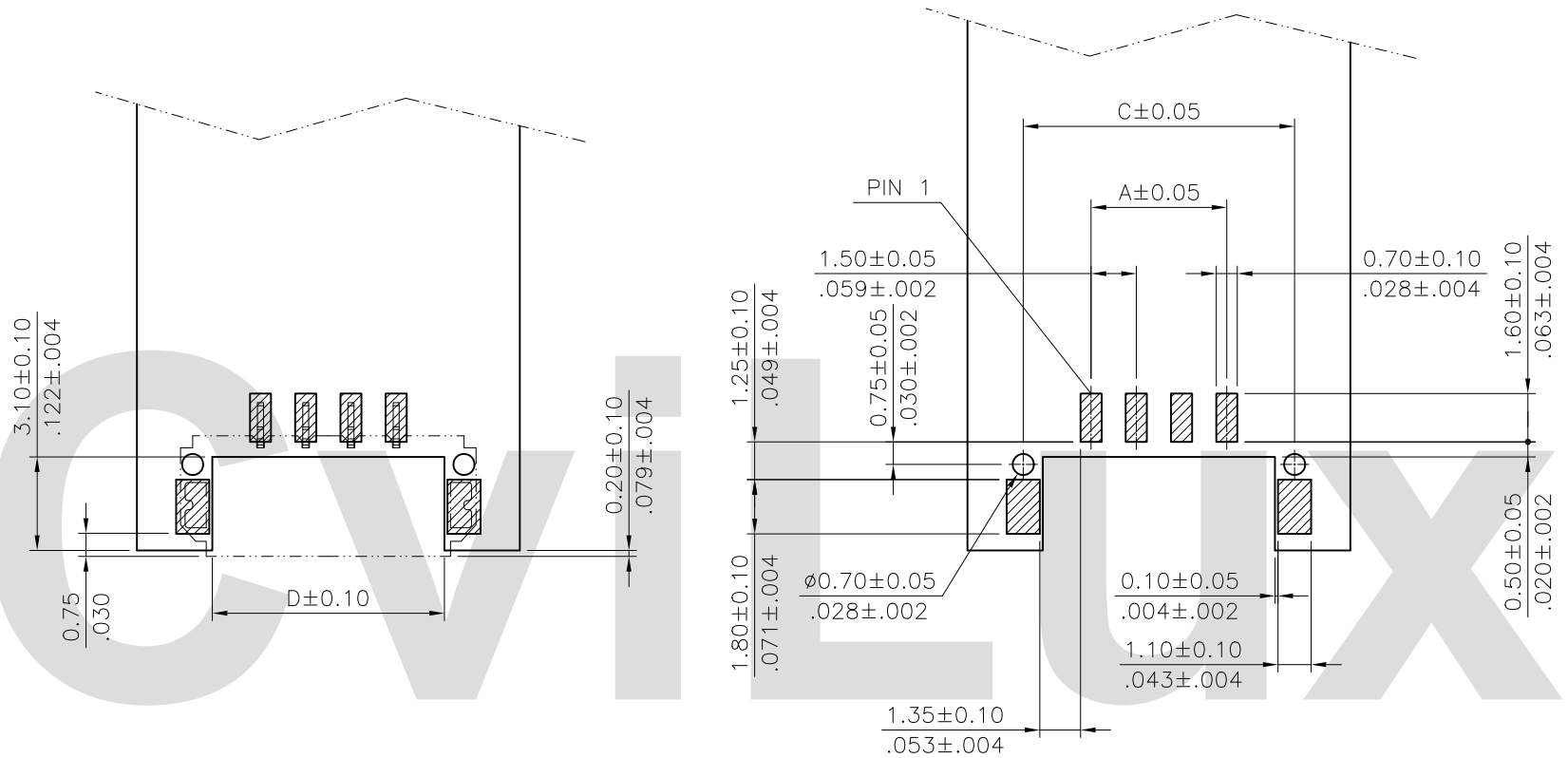

Recommended P.C.B Layout

Halogen-Free

Lead Free Process

RoHS Compliant

4					DATE	UNIT: mm / inch	TITLE: For CP15 series Plug conn.	 瀚荃股份有限公司 CviLux Corporation
3				DRAWN BY: Karen	8/13-14'	TOLERANCE UNLESS OTHERWISE SPECIFIED	MATERIAL:	
2	Karen	8/13-14'	ECNT114178	ENGINEER: Sun	8/14-14'	.X ± 0.30/.012 X' ± r'		
1	Clark	08/08-12	ECN12186-0	CHECKED BY: Eisley	8/15-14'	.XX ± 0.20/.008 X' ±	DRAWING NO. CP1501SB PART NO. CP15**M1PRO-NH	
SYM	NAME	DATE	REVISIONS	APPROVED BY: Eisley	8/15-14'	.XXX ± 0.10/.004 XX' ±	SCALE 4 / 1	SHEET 2 OF 4

CVILUX CORP
 2014.08.22
 ISSUED

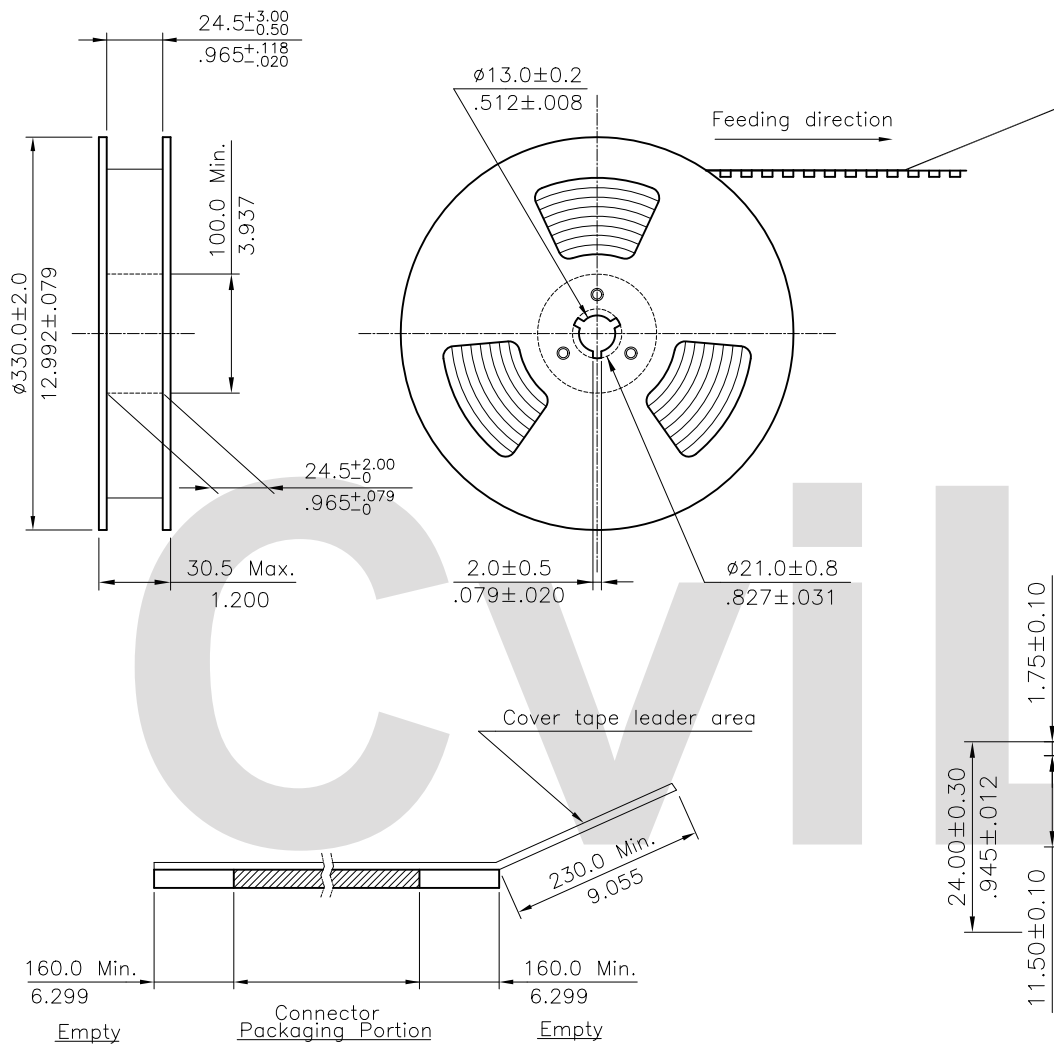

NOTE :

- * Reel Material : Corrugated Paper
- * Carrier Material : Clear, Conductive Polystyrene Alloy
- * Cover Tape Material : Polyester
- * Cover Tape Peel Strength : 0.1N – 1.3N
- * Carrier camber is within 1mm in 100mm
- * All dimensions meet EIA-481-2 & EIA-481-3 requirements.
- * Quantity : 1800 PCS/Reel
- * Packing : 9 Reel/Carton

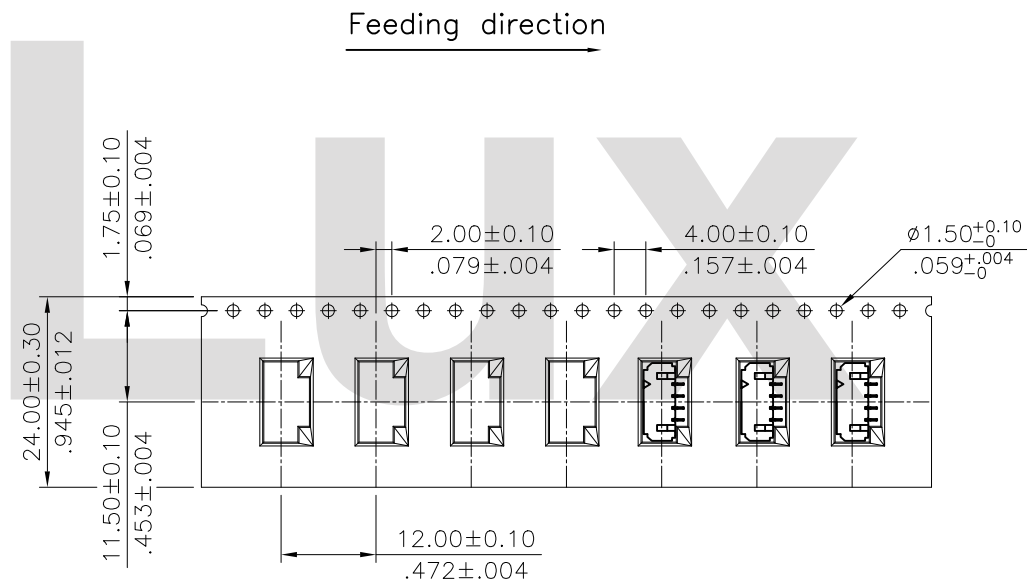

WIDTH : 24 mm Carrier

RoHS Compliant

4						DATE	UNIT: mm / inch	TITLE:	 瀚荃股份有限公司 CviLux Corporation
3			DRAWN BY: Karen		8/13-14'	TOLERANCE UNLESS OTHERWISE SPECIFIED		MATERIAL:	
2	Karen	8/13-14'	ENGINEER: Sun		8/14-14'	.X ±	X' ± 1'	FINISH:	
1	Clark	08/08-12	CHECKED BY: Eisley		8/15-14'	.XX ±	.X ±		
SYM	NAME	DATE	APPROVED BY: Eisley		8/15-14'	.XXX ±	.XX ±	SCALE	
		REVISIONS						SHEET 3 OF 4	

Mating

Step 1: The male header should be tilted during insertion.

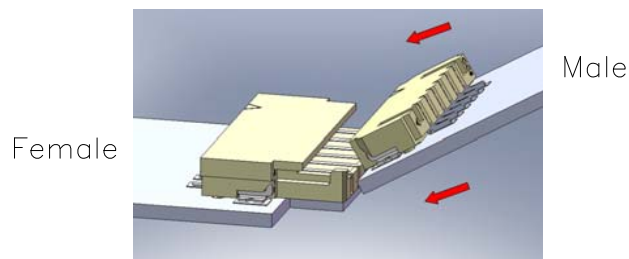

Step 2: Push the male header to the end. Make sure the male header is under the rib of female header by finger.

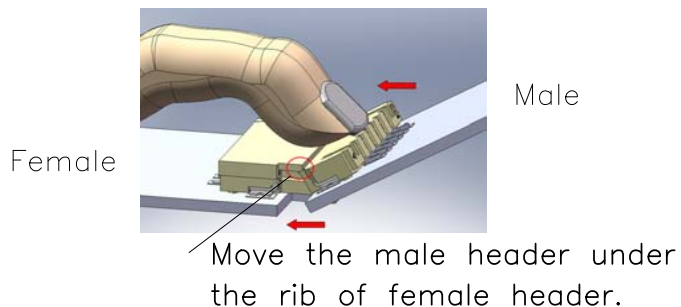

Step 3: Press down the male header down vertically to finish the connection.

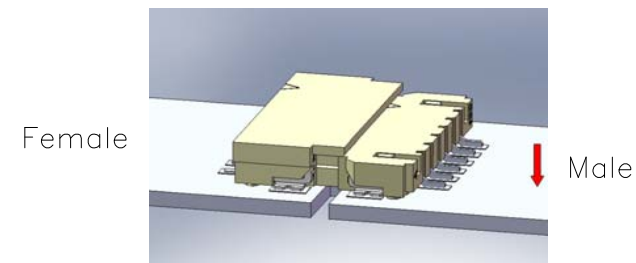

Unmating

Step 1: Lift the male header up at 30°~60°.

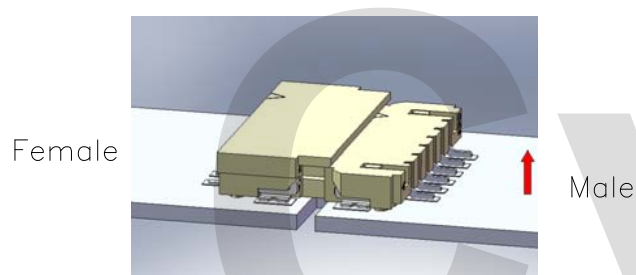

Step 2: Remove male header at an angle to finish the disconnection.

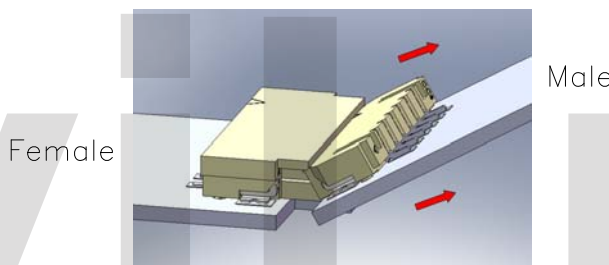

Step 3: Finish

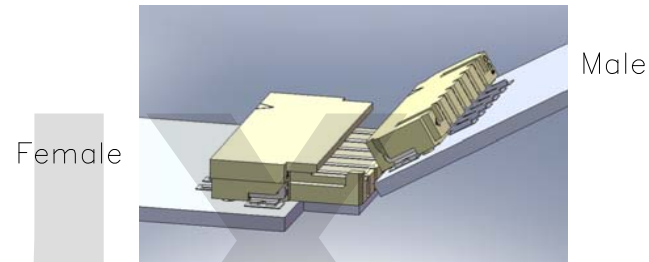

Please do not separate the connectors horizontally to prevent damaging them.

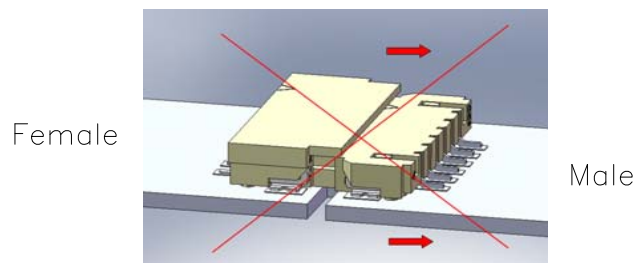

Please do not separate the connectors vertically to prevent damaging them.

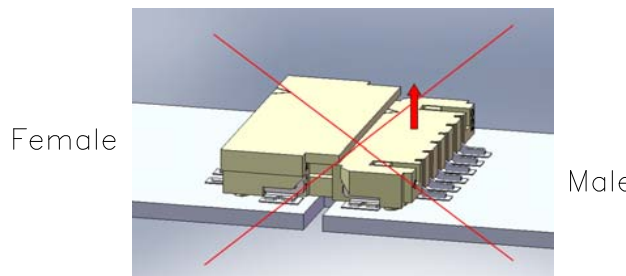

4					DATE	UNIT: mm / inch	TITLE:	 瀚荃股份有限公司 CviLux Corporation			
3				DRAWN BY: Karen	8/13-14'	TOLERANCE UNLESS OTHERWISE SPECIFIED	For CP15 series				
2	Karen	8/13-14'	ECNT114178	2014.08.22	ENGINEER: Sun	8/14-14'	MATERIAL:	DRAWING NO.	CP1501SB	PART NO.	CP15**M1PRO-NH
1	Clark	08/08-12	ECN12186-0	ISSUED	CHECKED BY: Eisley	8/15-14'	FINISH:	SCALE		SHEET	4 OF 4
SYM	NAME	DATE	REVISIONS		APPROVED BY: Eisley	8/15-14'					