

NOTE:

1. Material:
 Base: Nylon 6T + 30% GF. UL 94V-0, Color Nature
 Contact: Phosphor Bronze
 Tab: Brass, with Matte Tin plated
 PAD: Nylon 6T + 30% GF. UL 94V-0, Color Nature
2. For Lead Free IR Reflow Process

ORDERING CODE

CI11 ** M 1 V R0 - NH
 ① ② ③ ④ ⑤ ⑥ ⑦

- ① Series No.
- ② Contacts:
- ③ M= SMT type header
- ④ Plating:
 1= 100μ" Min. Matte Tin Plated over 50μ" Nickel
 2= Gold flash plated over 1.27μm(50μ") Nickel
- ⑤ Type: V= Straight
- ⑥ Other option:
 R0= Tape & reel packing (With pick & place pad)(Standard)
 RN= Tape & reel packing (without pack & place pad)
 T0= Tube packing (without pack & place pad)
- ⑦ -NH= For Lead Free IR Processes and Halogen-Free

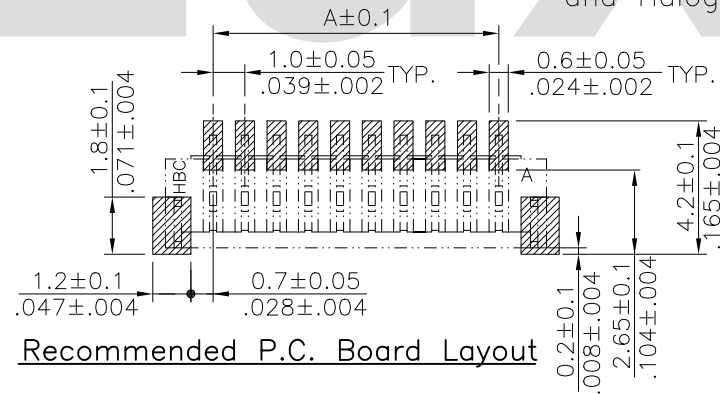
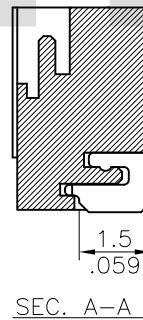
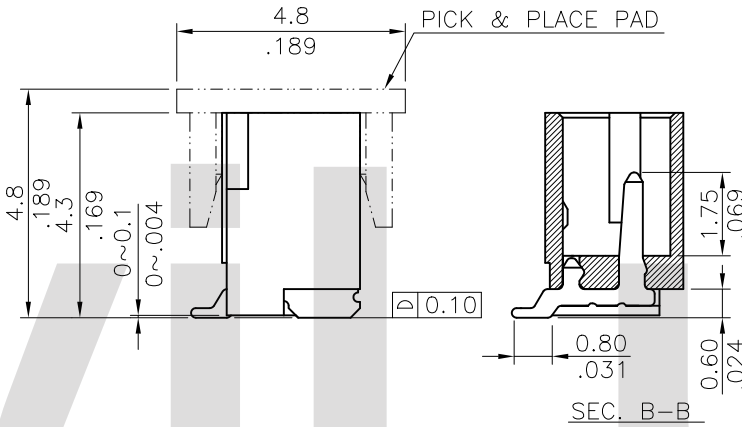
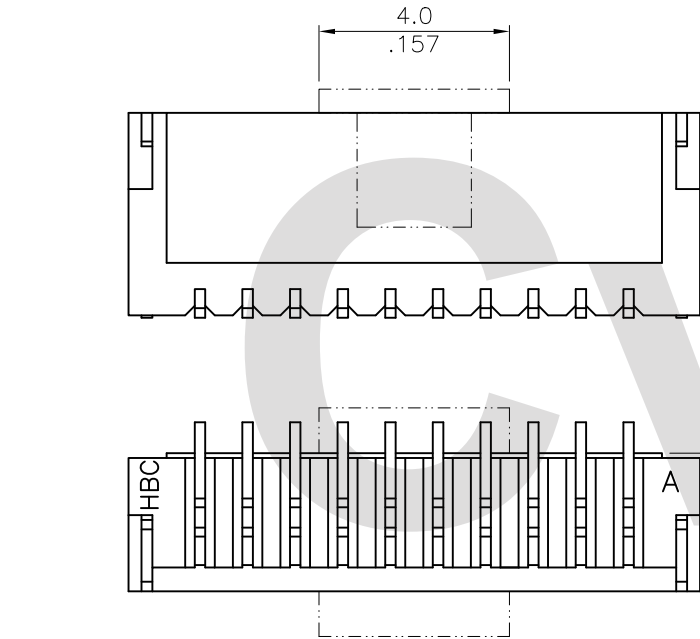

DIM. A = 1.00 x NO. OF SPACES
 DIM. B = DIM. A + 3.0

* AVAILABLE IN 2 THROUGH 18,20 AND 26 CIRCUITS

Halogen-Free

Lead Free Process

RoHS Compliant

④						DATE	UNIT: mm / inch	TITLE: 1.00MM(.079")	 瀚荃股份有限公司 CviLux Corporation
③	Ellie	12/19-14	ECNT114252/ECRT114090	2015.01.16	DRAWN BY:	Ellie	12/22-14'	WIRE TO BOARD CONNECTOR	
②	Enya	11/11-13	ECNT113103/ECRB113027	ISSUED	ENGINEER:	Sun	12/23-14'	MATERIAL:	
①	Sun	7/05-11	ECR10039-2/ECN11060		CHECKED BY:	Eisley	12/24-14'	FINISH:	
SYM	NAME	DATE	REVISIONS		APPROVED BY:	Eisley	12/24-14'		DRAWING NO. CI1152SD SCALE 6 / 1 PART NO. CI11**M**V**-NH SHEET 1 OF 2

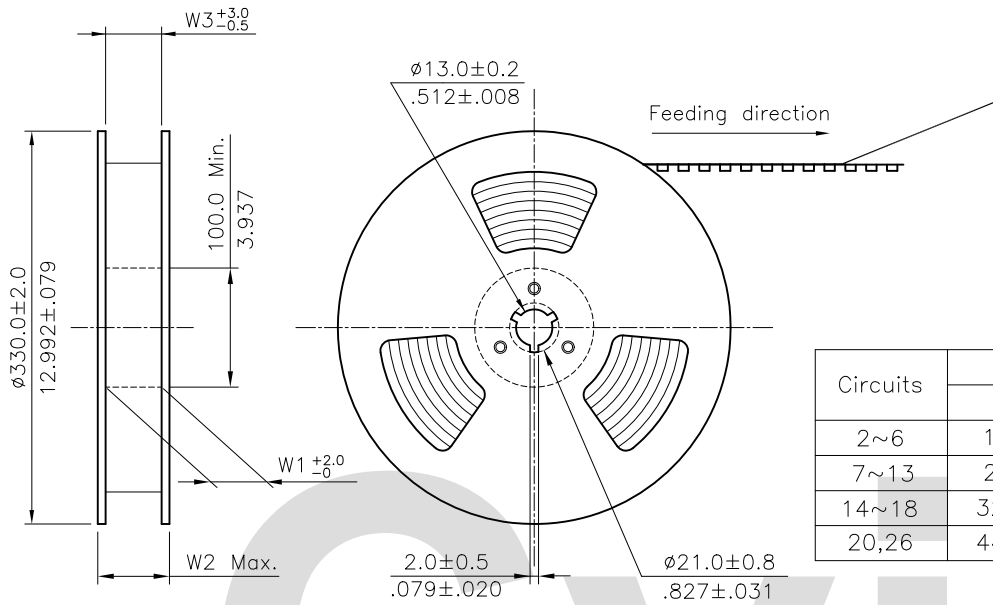

NOTE :

- △ * Reel Material : Corrugated Paper
- * Carrier Material : Clear, Conductive Polystyrene Alloy
- * Cover Tape Material : Polyester
- * Cover Tape Peel Strength : 0.1N – 1.3N
- * Carrier camber is within 1mm in 100mm
- * All dimensions meet EIA-481-2 & EIA-481-3 requirements.
- * Quantity : 1000 PCS/Reel

Circuits	Dimension					Packing (Reel/Caton)
	E	F	W1	W2	W3	
2~6	16.0(.630)	-	16.5(.650)	22.5(.886)	16.5(.650)	11
7~13	24.0(.945)	-	24.5(.965)	30.5(1.201)	24.5(.965)	9
14~18	32.0(1.260)	28.40(1.118)	32.5(1.280)	38.5(1.516)	32.5(1.280)	7
20,26	44.0(1.732)	40.40(1.591)	44.5(1.752)	50.5(1.988)	44.5(1.752)	5

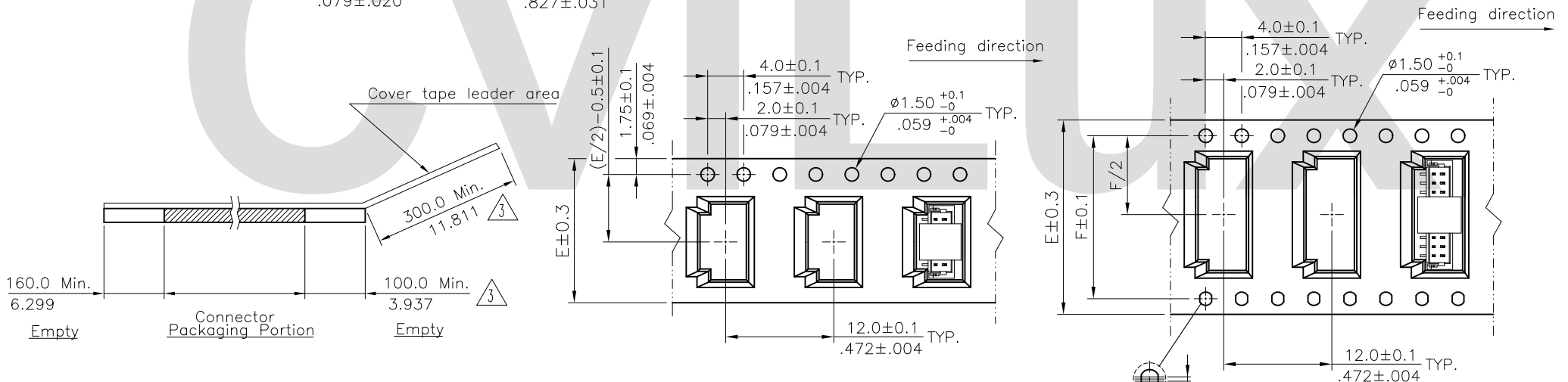

WIDTH : 16,24 mm Carrier

WIDTH : 32,44 mm Carrier

RoHS Compliant

SYM	NAME	DATE	REVISIONS	APPROVED BY:	DATE	UNIT: mm / inch	TITLE:	MATERIAL:	FINISH:	DRAWING NO.	PART NO.	SHEET	OF	2
4							1.00MM(.079")			CI1152SD	CI11**M*V**-NH	2	OF	2
3	Ellie	12/19-14	ECNT114252/ECRT114090	DRAWN BY:	Ellie	12/22-14'	WIRE TO BOARD CONNECTOR							
2	Enya	11/11-13	ECNT113103/ECRB113027	ENGINEER:	Sun	12/23-14'								
1	Sun	7/05-11	ECR10039-2/ECN11060	CHECKED BY:	Eisley	12/24-14'								
				APPROVED BY:	Eisley	12/24-14'								

CVILUX CORP
2015.01.16
ISSUED

瀚荃股份有限公司
CviLux Corporation