

**CF16 Series 1.00mm(.039")H=3.80/5.20 SMT LIF FFC/FPC Connectors**

- ⊙ Insulator: High temperature plastic UL 94V-0, Color Nature
- ⊙ With metal fixed tabs to secure connector in place

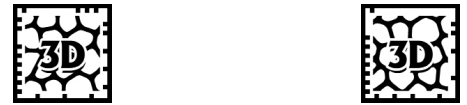

P/N CF16\*\*1M0\*0-NH

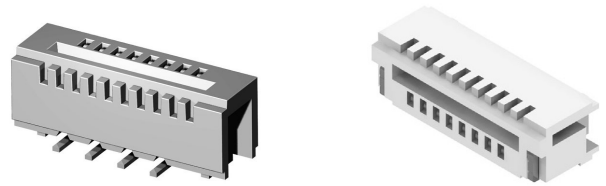
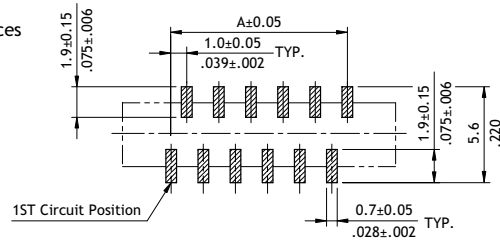
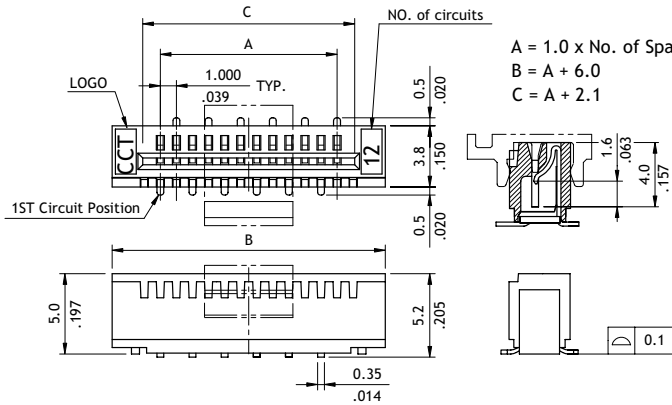

P/N CF16\*\*1S0\*0-NH

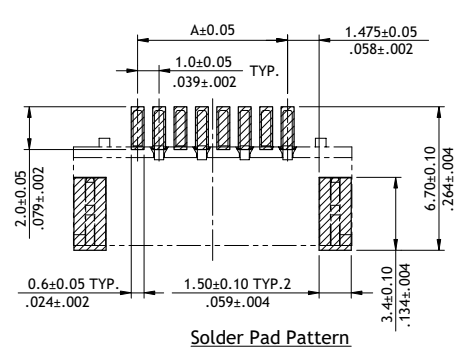
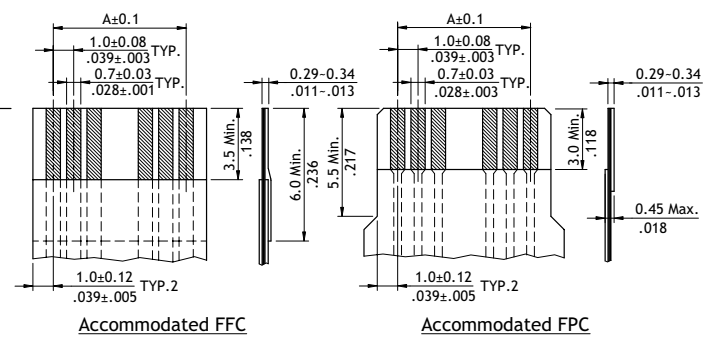
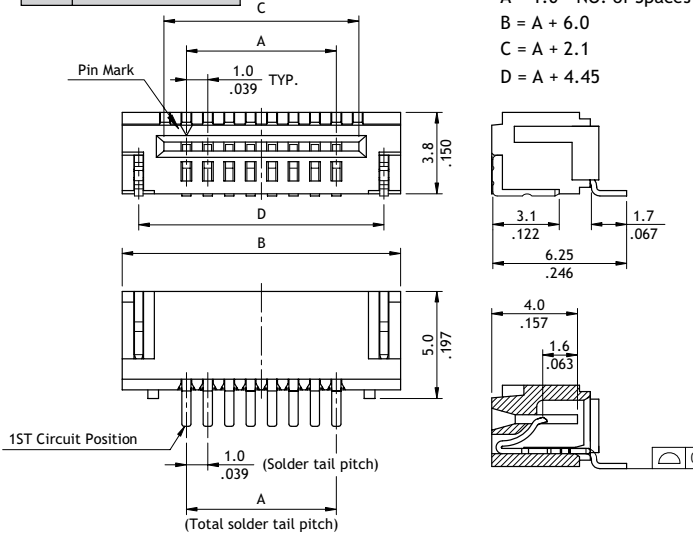

**Ordering Code**

**①** CF **②** 16 **③** 32 **④** 1 **⑤** V **⑥** 0 **⑦** T **⑧** 0 - NH

- ①** Series No.
- ②** No. of Circuits: 03 to 32
- ③** Plating Code:  
1 = Matte Tin over Nickel
- ④** Contact Style: U = Upside Contact (DIP)  
D = Downside Contact (DIP)  
V = Vertical Type (DIP)  
M = Top entry Type (SMT)  
S = Side entry Type (SMT)
- ⑤** Color: 0 = Nature
- ⑥** Packing: T = Tube packing without Pad (DIP or SMT)  
R = Reel packing (SMT)
- ⑦** Other Options: 0 = Standard  
\*Special options consult manufacturer
- ⑧** -LF = For Lead Free soldering process  
-NH = For Lead Free soldering process and Halogen-Free