

CF16 Series 1.00mm(.039")H=3.80/5.00 DIP LIF FFC/FPC Connectors

- Tin contacts with kinked tail
- Insulator: High temperature plastic UL 94V-0, Color Nature

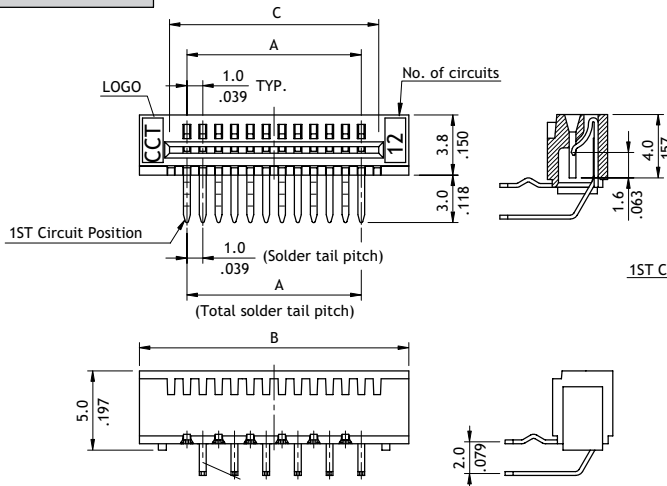

P/N CF16**1U0T0-NH



A = 1.0 x No. of Spaces
 B = A + 6.0
 C = A + 2.1

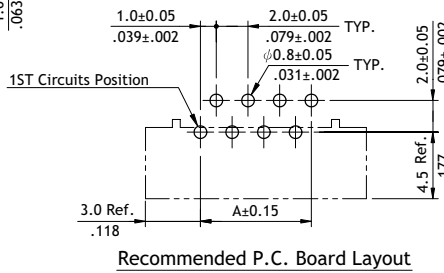
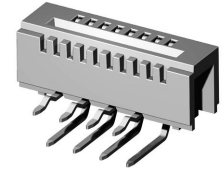

P/N CF16**1D0T0-NH

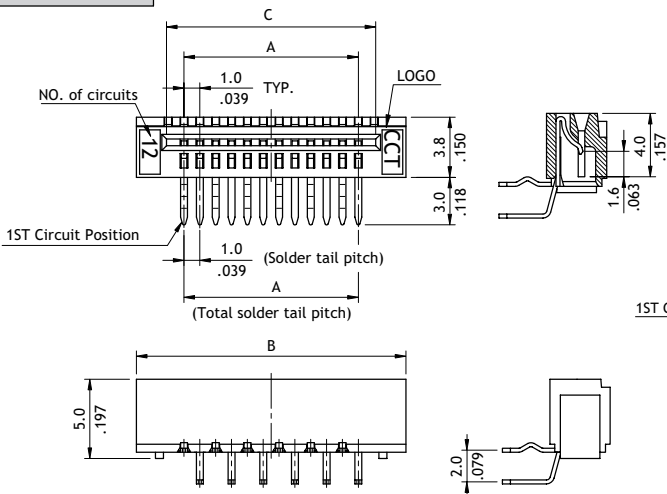

A = 1.0 x No. of Spaces
 B = A + 6.0
 C = A + 2.1

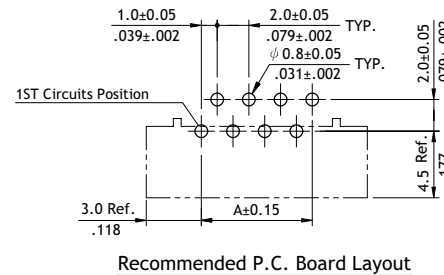
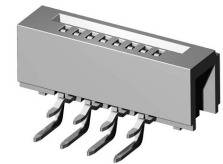

P/N CF16**1V0T0-NH

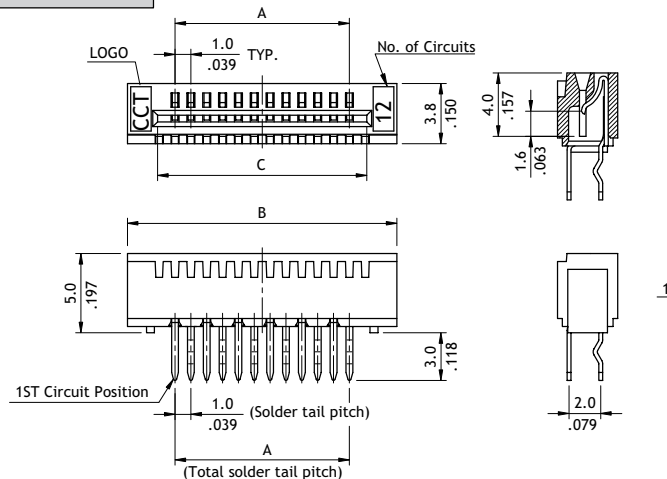

A = 1.0 x No. of Spaces
 B = A + 6.0
 C = A + 2.1

