

CJ59 Series Board Mount Telephone Jacks

- Available from 6, 8 and 10 ways
- Insulator: Black, Glass Filled polyester
- Flammability Rating: UL 94V-0
- Cavity confirms to FCC rules and regulations PART 68, SUBPART F

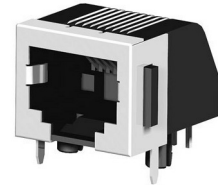

P/N CJ596*A1100

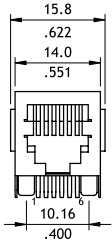

6 Positions

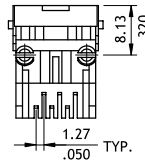
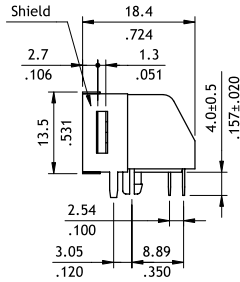

Bottom View

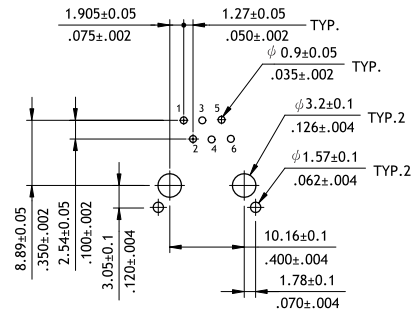

Recommended PC Board Layout

P/N CJ5988A1100

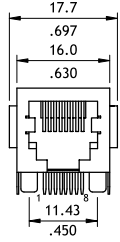

8 Positions

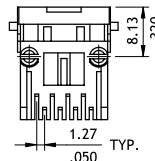
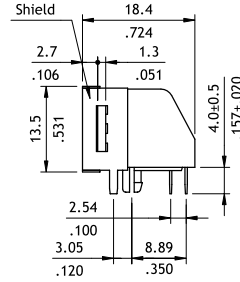

Bottom View

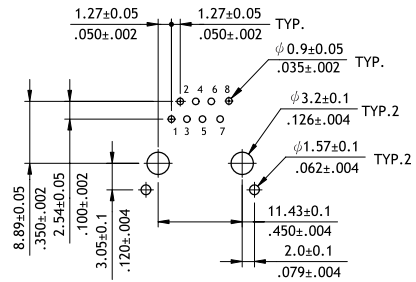

Recommended PC Board Layout

P/N CJ5988A110K

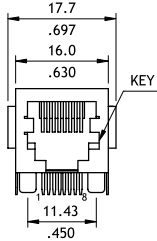

8 Positions

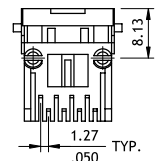
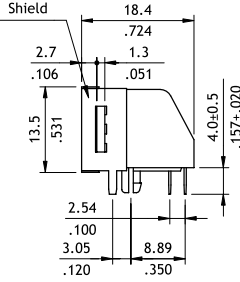

Bottom View

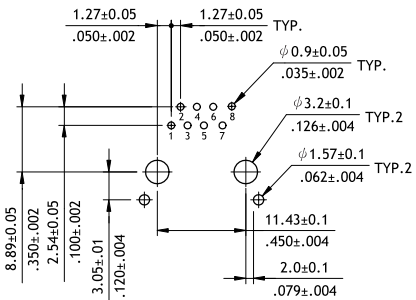

Recommended PC Board Layout

P/N CJ59AAA1100

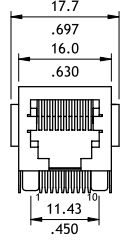

10 Positions

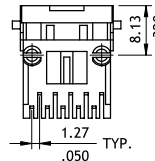
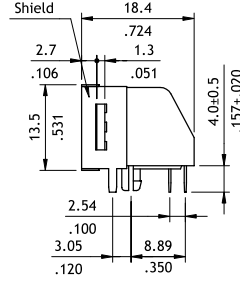

Bottom View

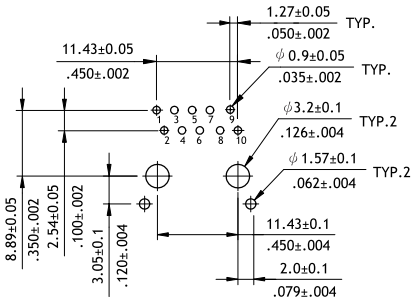

Recommended PC Board Layout

3

TELEPHONE / MODULAR JACK