

**CF31 Series 1.00mm(.039")H=1.95 SMT ZIF One-Touch FFC/FPC Connectors**

- ⊙ 1.95mm above the board
- ⊙ FFC/FPC zero insertion force and high retention force
- ⊙ Insulator: High temperature plastic UL 94V-0, Color Nature
- ⊙ Cover: High temperature plastic UL 94V-0, Color Black
- ⊙ Designed easy for FFC/FPC installation and reliable operation
- ⊙ With metal fixed tabs to secure connector in place

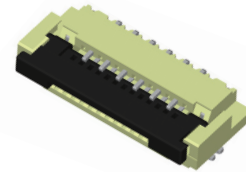

**RoHS** Compliant  

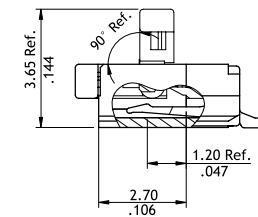
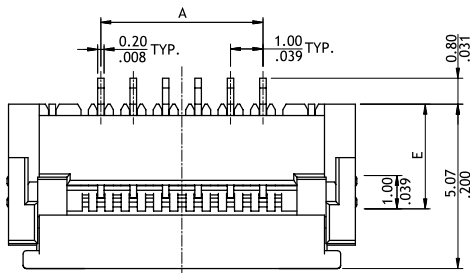

A = 1.0 x No. of Spaces  
 B = A + 5.7  
 C = A + 2.1  
 D = A + 5.8

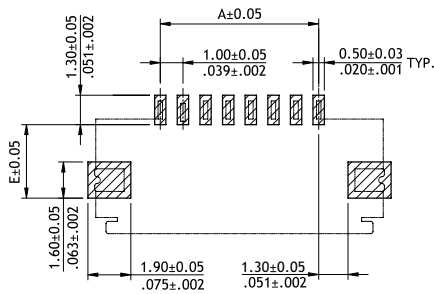
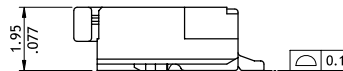
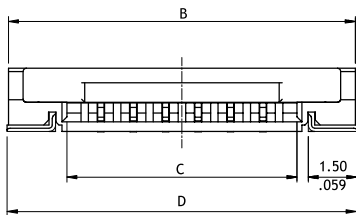
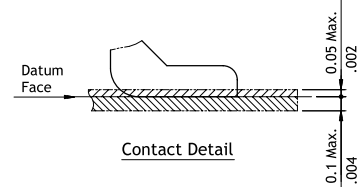

Recommended P.C. Board Layout

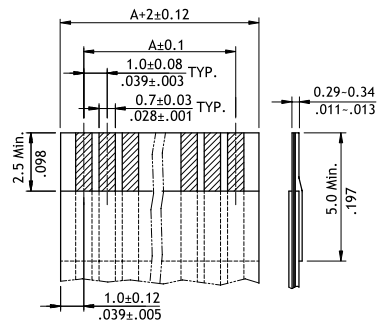

Accommodated FFC/FPC

**Ordering Code**

**①** CF **②** 3 **③** 1 **④** 2 **⑤** 6 **⑥** 1 **⑦** D **⑧** 0 **⑨** R **⑩** 0 - **⑪** 10 - **⑫** NH

- ①** Series No.
- ②** No. of Circuits: 04 to 30  
\*Circuits not found above please consult manufacturer\*
- ③** Plating Code:  
1 = Matte Tin over Nickel  
2 = Gold flash over Nickel
- ④** Contact Style:  
D = Downside Contact
- ⑤** Color: 0 = Nature
- ⑥** Packing:  
R = Tape & Reel
- ⑦** Other Options:  
0 = Without Mylar, E=3.20mm  
2 = Without Mylar, E=2.85mm
- ⑧** Pitch: 10 = 1.00 mm
- ⑨** -NH = For Lead Free IR process and Halogen-Free